

## Description

The DFSSD24C is designed to replace multilayer varistors(MLVs) in portable applications such as cell phones, notebook computers and PDA's, using monolithic silicon technology to provide fast response time and ultra low ESD clamping voltage, making this device an ideal solution for protecting sensitive semiconductor components from damage. The DFSSD24C complies with the IEC 61000-4-2 (ESD) standard with  $\pm 30\text{kV}$  air and  $\pm 30\text{kV}$  contact discharge. It is assembled into a lead-free SOD-323 package and will protect one bidirectional line. These devices will fit on the same PCB pad area as an 0805 MLV device.

## Features

- ◆ 675W peak pulse power (8/20 $\mu\text{s}$ )
- ◆ Protects one data or power line
- ◆ Ultra low leakage: nA level
- ◆ Operating voltage: 24V
- ◆ Ultra low clamping voltage
- ◆ Complies with following standards:
  - IEC 61000-4-2 (ESD) immunity test
    - Air discharge:  $\pm 30\text{kV}$
    - Contact discharge:  $\pm 30\text{kV}$
  - IEC61000-4-4 (EFT) 40A (5/50ns)
  - IEC61000-4-5 (Lightning) 13A (8/20 $\mu\text{s}$ )
- ◆ RoHS Compliant

## Mechanical Characteristics

- ◆ Package: SOD-323
- ◆ Lead Finish: Matte Tin
- ◆ Case Material: "Green" Molding Compound.
- ◆ UL Flammability Classification Rating 94V-0
- ◆ Moisture Sensitivity: Level 3 per J-STD-020
- ◆ Terminal Connections: See Diagram Below
- ◆ Marking Information: See Below

## Applications

- ◆ Cellular Handsets and Accessories
- ◆ Personal Digital Assistants
- ◆ Notebooks and Handhelds
- ◆ Portable Instrumentation
- ◆ Peripherals
- ◆ Pagers Peripherals
- ◆ Desktop and Servers

## Dimensions and Pin Configuration

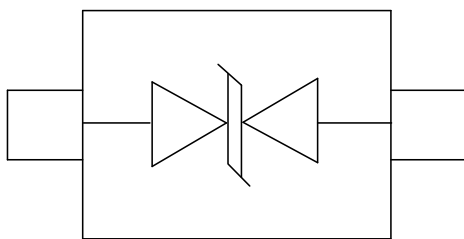

Circuit and Pin Schematic

## Marking Information



24H= Device Marking Code

## Ordering Information

Part Number	Marking	Packaging	Reel Size
DFSSD24C	24H	3000/Tape & Reel	7 inch

### **Absolute Maximum Ratings ( $T_A=25^{\circ}\text{C}$ unless otherwise specified)**

Parameter	Symbol	Value	Unit
Peak Pulse Power (8/20 $\mu\text{s}$ )	Ppk	675	W
Peak Pulse Current (8/20 $\mu\text{s}$ )	Ipp	13	A
ESD per IEC 61000-4-2 (Air) ESD per IEC 61000-4-2 (Contact)	VESD	$\pm 30$ $\pm 30$	kV
Operating Temperature Range	TJ	-55 to +125	$^{\circ}\text{C}$
Storage Temperature Range	Tstg	-55 to +150	$^{\circ}\text{C}$

### **Electrical Characteristics ( $T_A=25^{\circ}\text{C}$ unless otherwise specified)**

Parameter	Symbol	Min	Typ	Max	Unit	Test Condition
Reverse Working Voltage	VRWM			24	V	
Breakdown Voltage	VBR	26.70			V	IT = 1mA
Reverse Leakage Current	IR			0.2	$\mu\text{A}$	VRWM = 24V
Clamping Voltage	VC		30	35	V	I <sub>PP</sub> = 1A (8 x 20 $\mu\text{s}$ pulse)
Clamping Voltage	VC		52	57	V	I <sub>PP</sub> = 13A (8 x 20 $\mu\text{s}$ pulse)
Junction Capacitance	CJ		32		pF	VR = 0V, f = 1MHz

**Typical Performance Characteristics (TA=25°C unless otherwise Specified)**

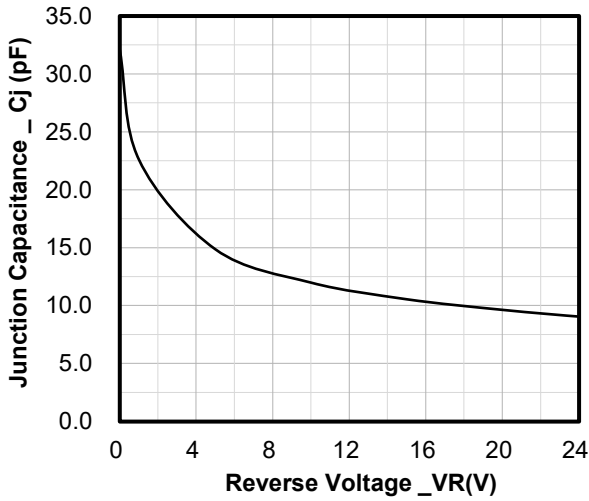

**Junction Capacitance vs. Reverse Voltage**

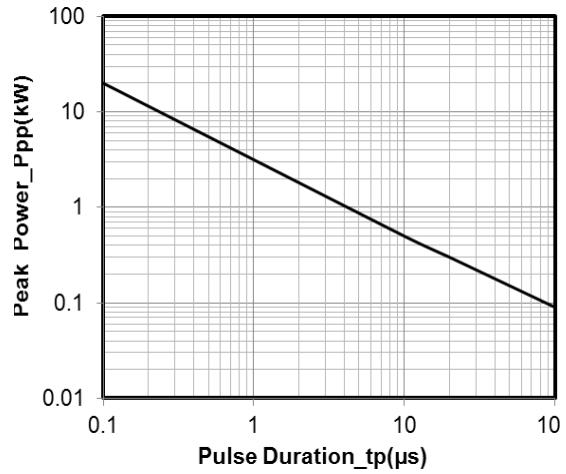

**Peak Pulse Power vs. Pulse Time**

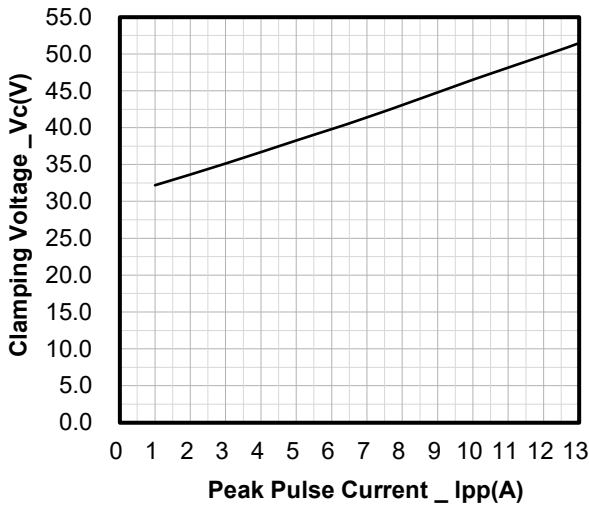

**Clamping Voltage vs. Peak Pulse Current**

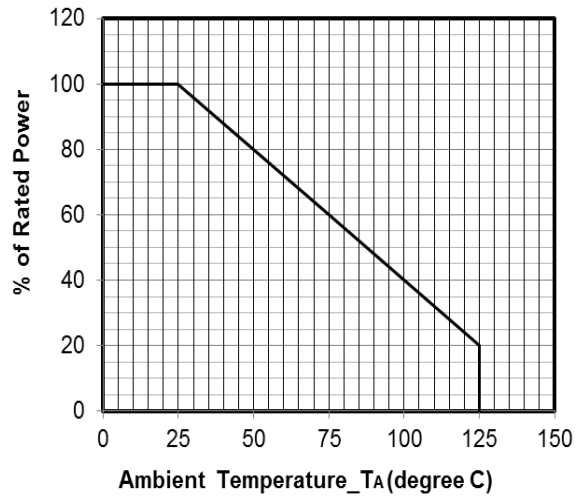

**Power Derating Curve**

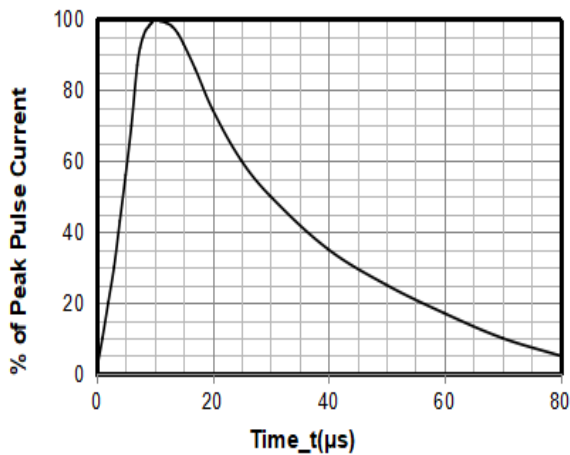

**8 X 20μs Pulse Waveform**

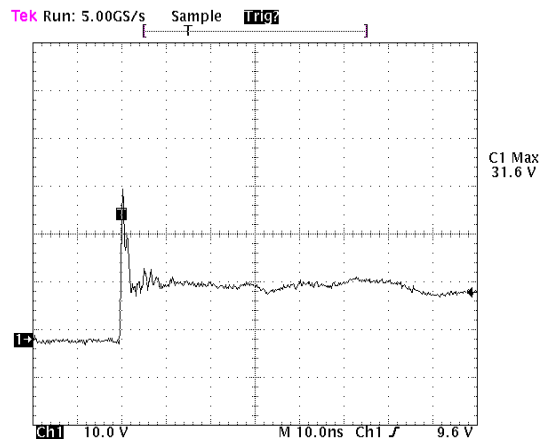

Note: Data is taken with a 10x attenuator

**ESD Clamping Voltage  
8 kV Contact per IEC61000-4-2**

## SOD-323 Package Outline Drawing

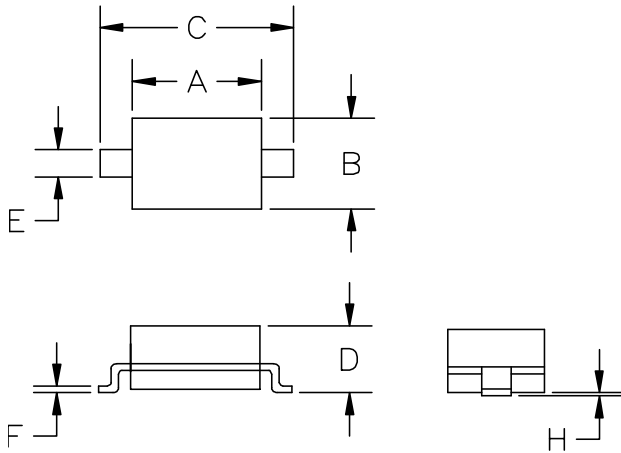

SYM	DIMENSIO			
	MILLIMETERS		INCHES	
	MIN	MAX	MIN	MAX
A	1.50	1.80	0.060	0.071
B	1.20	1.40	0.045	0.054
C	2.30	2.70	0.090	0.107
D	-	1.10	-	0.043
E	0.30	0.40	0.012	0.016
F	0.10	0.25	0.004	0.010
H	-	0.10	-	0.004

## Suggested Land Pattern

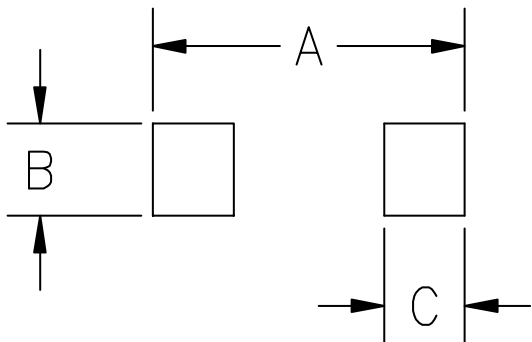

SYM	DIMENSIONS	
	MILLIMETERS	INCHES
A	3.15	0.120
B	0.80	0.031
C	0.80	0.031

## Contact Information

Changzhou D-first Electronics CO.,Ltd.

[www.first-electronic.com](http://www.first-electronic.com)

Email: [xhf@first-electronic.cn](mailto:xhf@first-electronic.cn)

Phone: +86 (0519) 8817 1671